



Gunnebo SpeedStile FP

BA/EV Series

Full Panel Speed Gate for Internal Installation

Full Panel Speed Gate for Internal Installation

Motorised full glass sliding leaves 1.2 or 1.8m height

Exclusive and timeless award winning design. Silent and smooth in operation, this classic Gunnebo Speed Gate design is available in the BA version in polyurethane colour finish or with stainless steel cabinets in the EV version, with a selection of top lid materials, side panels and many other customisation options including Lift Screen integrations.

Applications include Government, Finance, Banking, Retail, Telecommunications, Information Technology, Publishing, Leisure, Education...

Security Features

Fraud Detection through sophisticated and proven algorithm

Intrusion
Tailgating
Piggybacking
Wrong way direction
Leave aisle timeout
Anti-crawling flap leaf barrier

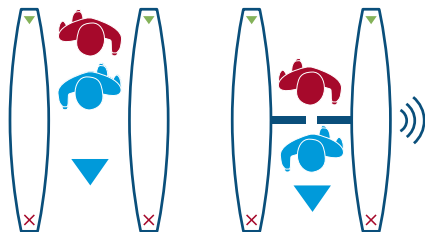

Tailgating and piggybacking detection

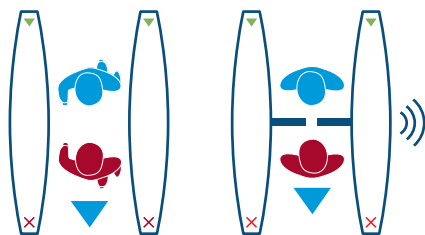

Wrong way and intrusion detection

Mode of Operation

Flap Leaves

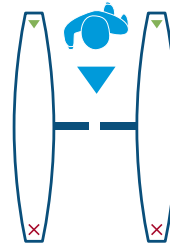

Normally Closed

Passage in one or both directions electronically controlled. On receiving a signal from the access control system, or remote control, the flap leaves open (Normally Closed NC). If an unauthorised person

tries to tailgate or attempts to enter from the opposite direction, the in-built alarm system is activated. If within the pre-set timeout no passage has occurred, the lane will close and reset.

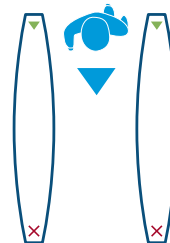

Normally Open

Normally Open N/O provides an open walkway in rest position and will only close at unauthorised entry or tailgating attempts.

Illuminated symbols

Steady light=Normal use. Flashing light=Alarm conditions.



Green Card

Steady: Rest mode. Present card to the reader for authorization.

Flashing: Incorrect use, re-present card to the reader for authorization.

Green Arrow

Steady: Authorized use or designated free passage. Proceed through the unit.

Flashing: Emergency/Fire exit.

Red Cross

Steady: Unit in use or no passage. Passage not authorised.

Flashing: Alarm, fraudulent condition or technical alarm.

Available optional 50mm diameter LED display pictogram and LED way-mode indicators flush mounted within the lid surface and the end leg, with illuminated symbols.



Safety Features

Safety rubber edges
Accurate presence sensing
Emitter/receiver infrared sensors technology
Logic voltage 24 Vac
Voltage free contact input for Fire Alarm fail state
Fail-Safe manual push opening
Fail-Safe via battery back-up opening (option)
Wide walkway for wheel chair or easier access
Accompanied wheelchair or Child passage management

For security and safety reasons children must be supervised by an adult at all times in the vicinity of an active lane. Any child being escorted through the lane must always precede the accompanying adult during passage.

Design/Construction

Available versions are the BA finish in polyurethane PUR painted, and the EV in Stainless Steel finish. Available cabinet design construction (for both versions).

Short cabinet length (N/C): 1.2m panel height

Long cabinet length (N/O): 1.8m panel height

Standard passage way 550mm and Wide passage (900mm) available. Available also as Combi – centre cabinet with narrow (550mm) passage in one side and wide (900mm) passage on the other side.

In order to create a lane it is necessary to use one right and one left cabinet. To create more than one lane, use one or more centre or combi cabinets. Select cabinets according to the number of lanes and passage width desired.

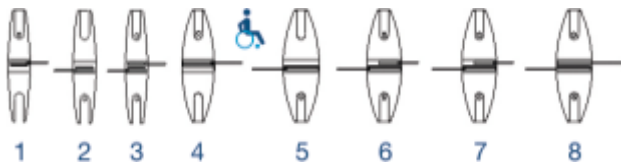

1. Left Cabinet 2. Right Cabinet 3. Centre Cabinet
 4. Left Wide Cabinet 5. Right Wide Cabinet 6. Centre Left Wide Cabinet
 7. Centre Right Wide Cabinet 8. Centre Wide Cabinet



Two lane configuration comprising of 1N°L, 1N°C and 1N°R cabinets

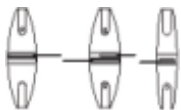

Two lane configuration comprising of N°1 LW, 1N°CLW and 1N°R cabinet.

Finishes

BA and EV versions share the same cabinet plinth and inlay finish in 304 grade stainless steel, wings 12mm toughened glass with rubber safety edge.

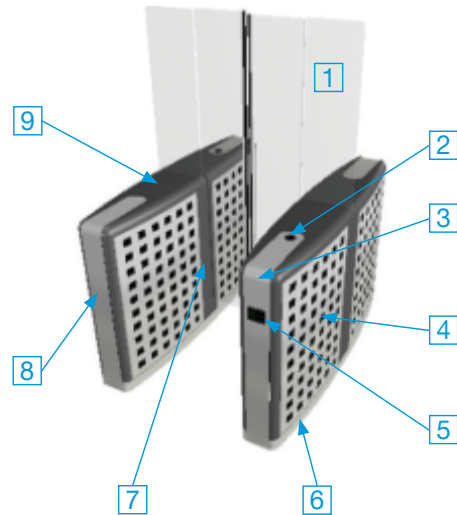

1. Flap Wings. 2. Pictogram. 3. Card reader integration.
 4. Side Panels. 5. LED display indicators. 6. Plinth. 7. Wing housing.
 8. End Leg. 9. Lid.

Standard finishes

	BA	EV
Standard finish	Metallic grey	Full stainless steel 304 grade
Lid	Painted polyurethane	Stainless steel
End Legs	Painted polyurethane	Stainless steel
Wing housing	Painted steel to match lid	Stainless steel
Side Panels	Acrylic and stainless steel	8.5mm 3 ply laminate safety glass

Selection of alternative materials and finishing available for Side Panels



- PMMA & Stainless Steel
- 8.5mm 3ply laminate safety glass
- Full Stainless Steel

Options & Accessories

Alternative finishes and materials	Battery back-up
LED way mode indicator	Digital LCD counter
Pictogram	Emergency break glass push button
Card reader integration	Remote control systems
Fail Safe mechanical opening	Lift screen integrations

Access Specifications

Flow rates by type of reader¹

Insertion type	Swipe type	Proximity type
20 Passages per minute	30 Passages per minute	40 Passages per minute

1. Approximate figures.

Accessibility for Standard (550mm) vs. Wide (900mm) models

Plain dot indicates the functionality is implemented, empty dot indicates some limitations, no dot indicates not available. Emergency egress functionality implemented as standard.

550mm	•	•	•	•	•	•	○	○			○
900mm	•	•	•	•	•	•	○	○	•	•	•

Disabled Access: 900mm net passage way and algorithm able to manage wheelchair access.

Electrical Data & Conditions of Use

Power Supply	Power Rating	Power Rating	Battery Back-up	Fire Signal	Operating Temperature	IP Rating	Noise Level
230Vac 50Hz ¹	60VA ³ Stand by	345VA ³ In operation	For 1 last operating cycle ²	Input for voltage free contact	+5°C to + 40°C RH 95% No condensing	IP20	Less than 55dB ⁴

1. 115Vac 60Hz also available on demand. 2. Option 3. 46VA stand by, 700VA in operation with Fail-Safe option.
4. Note: Average background noise in office environment is 50-55dB

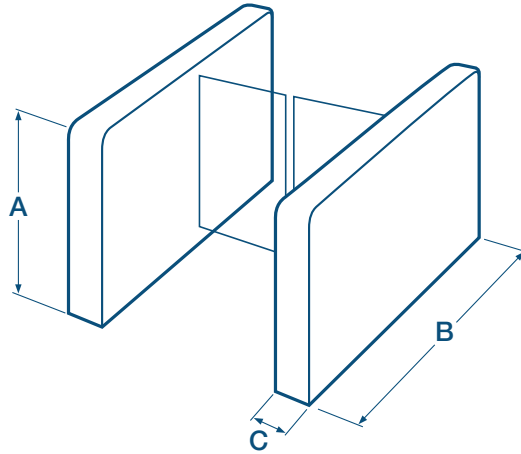

Dimensions & Weights

	Overall Height	Passage Width	A Cabinet Height	B Cabinet Length	C Cabinet Width	Weight (kg) Side Cabinet	Weight (kg) Centre Cabinet
Standard short lane	1200/1800	550	950	1448	300	170	220
Wide short lane	1200/1800	900	950	1448	480 (490 for EV)	185	240
Standard long lane	1200/1800	550	950	1932	300	260	300
Wide long lane	1200/1800	900	950	1932	480 (490 for EV)	320	360

Dimensions in (mm). Weight net (kg). Might require lifting equipment. For details refer to installation detail drawings

Installation & Maintenance

Product Delivery	Application	Site Preparation ¹	Cabling & Conduits ²	Control Board Location	Systems Integration ⁵	Systems Integration ⁵	Maintenance Access	MTTR ³	MCBF ⁴
Fully assembled	Indoor	Flat & level finished floor +/- 5mm	Through the ground	In master SpeedStile cabinet	27 Digital interface I/O RS232 RS485	Settings programmable via parameters	Through end leg panel	Less than 30 minutes	4 million (5 million if NO)

1. Bolting depth MIN 70mm, concrete MIN fckcube30N/mm² resistance, MIN 1500 (2000 for NO) x 500 (750 wide or combi) x 150mm deep. 2. Running MIN 140mm below finished floor level, should rise MIN 50mm from foundation. 3. Mean time to repair. 4. Mean cycle between failure. 5. Potential free contact for card reader input. New electronic platform with in-built RS485 and COMR1 switching interface.

It is the customer's responsibility to ensure the structural integrity and strength of the installation location.

Data provided is for information only, please refer to your usual Gunnebo Customer Service contact in order to prepare the installation site.



Want to see SpeedStile FP BA/EV in full action?
Scan this QR code with your smartphone.
Or search for "SpeedStile FP BA/EV" on YouTube.

Gunnebo SpeedStile FP



Take advantage of our knowledge:
www.gunneboentrancecontrol.com

GUNNEBO[®]
Entrance Control